

RIVKLE®

Automatic setting machines for RIVKLE®
blind rivet nuts and studs

BÖLLHOFF

Contents

	Page
RIVKLE® - Blind rivet nuts	3
Principal and mechanical characteristics	3
Setting methods	3
RIVKLE® - Setting machines	5
Semi-automatic setting tools - RIVKLE® EPK Compact - EPK HP	6
Automatic setting systems	8
Automatic setting tool - RIVKLE® HSA 2.0	9
Automatic setting tool - RIVKLE® ESA 2.0	10
Applications	11
The BÖLLHOFF service and expertise	11

See also our power hand tools offer



RIVKLE® – Principal and mechanical characteristics

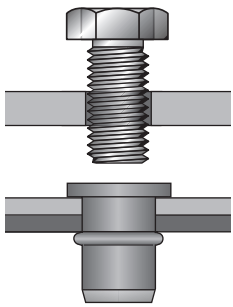

- When installed into the workpiece, RIVKLE® blind rivet nuts have two functions:
- A RIVET function allows two or more sheets to be permanently joined
 - A NUT function provides a reusable anchor for assembly of single or multiple sheets.

RIVKLE® blind rivet nuts can be installed in many types of workpiece (metal, plastic, composite, etc.) without surface damage to painted or pre-treated panels.

The RIVKLE® blind rivet nuts are available in a wide variety of combinations:

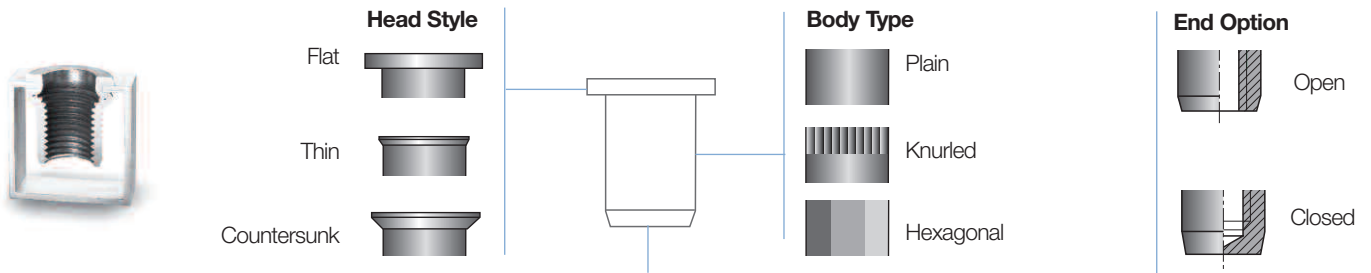

RIVKLE® blind rivet nut – Setting methods

The recommended setting methods are the “Stroke method” and the “Pressure method”.

1 - Pull methods

The “pull method” consists of: Spin on **1**, Insert **2**, Upset **3** and Spin off **4** cycles.

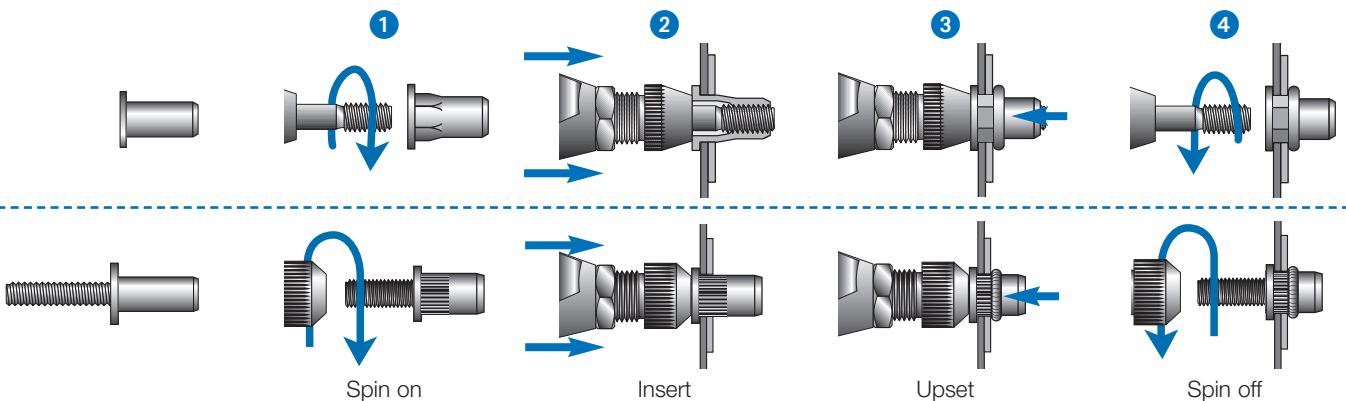

We do not recommend the use of mechanical screw-drivers or spanners for assembly of blind rivet nuts as there is a risk of damage to the thread surface and thus a detrimental effect on the joint.

The setting force is dependent on the combination of RIVKLE® material and thread diameter.

	Steel Force in kN	Stainless steel Force in kN	Aluminium Force in kN
M3	3,5	3,5	1,9
M4	5,5	5,5	3,0
M5	8,0	8,0	3,8
M6	12,0	13,0	5,5
M8	18,0	20,0	10,0
M10	21,0	22,0	12,0
M12	23,0	28,0	15,0

The setting forces indicated above represent the maximum load to properly set RIVKLE® blind rivet nuts. Higher forces could damage the RIVKLE® thread or the setting tool mandrel.

RIVKLE® blind rivet nut – Setting methods

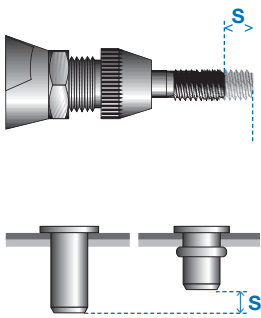

2 - Pull setting methods

2.1 Stroke setting method: control of the assembly tool stroke distance

The operator sets the stroke on the setting tool in accordance with the values shown in the RIVKLE® catalogue tables. The setting tool exerts the maximum pressure and automatically stops when the preset stroke is reached (mechanical stop).

This represents the traditional way to install a RIVKLE® but this method is neither adapted or reliable for process control.

2.2 Pressure setting method: force controlled installation

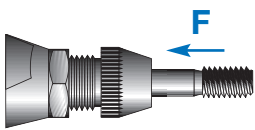

In the stroke setting method, the tool delivers maximum and constant force over the full stroke of the mandrel. Where there is a wide variation in thickness of the workpiece there is a definite risk that a blind rivet nut may not set properly, or become damaged due to the setting mandrel damaging the RIVKLE® thread. In this situation there will be premature wear of the mandrel.

This issue is eliminated with the pressure setting method as the setting force is controlled regardless of the thickness of the workpiece.

This setting principle is particularly well suited to workpieces with variable thickness (plastic parts, various layers...) and provides consistent setting quality and allows reliable and precise process control.

This is why BÖLLHOFF automation machines are based on pressure setting technology.

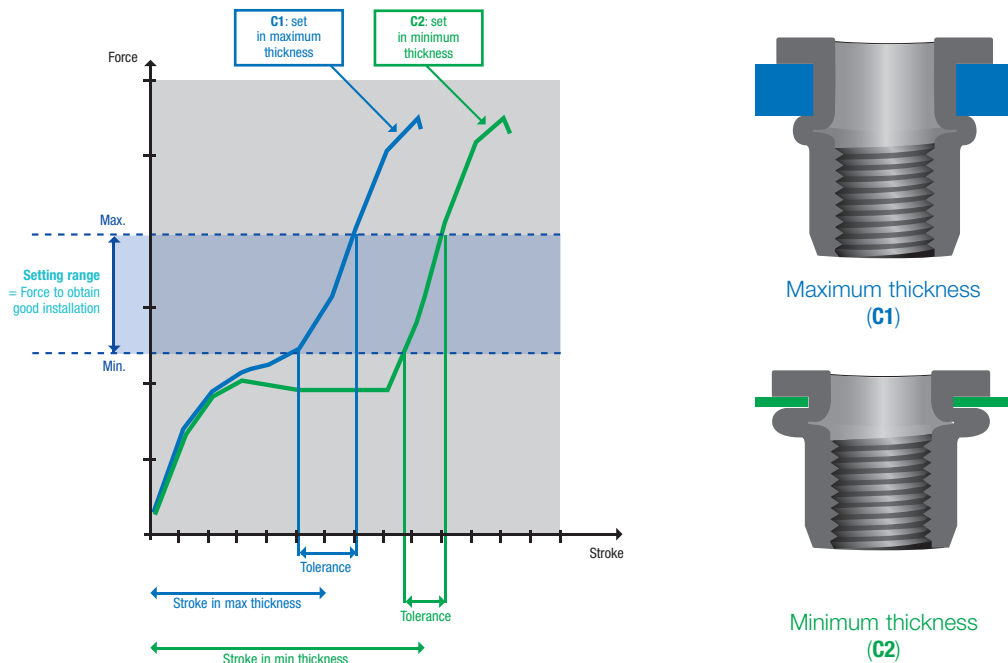

With the pressure setting method, you can verify after setting, if the stroke is within the preset window for the application. In this way, we carry out a setting quality control on 100% of the assembled products.

Our range of RIVKLE® EPK, RIVKLE® EPKC and RIVKLE® HSA devices incorporate process monitoring which ensures correct setting (installation) parameters and controlled process.

RIVKLE® – Setting machines

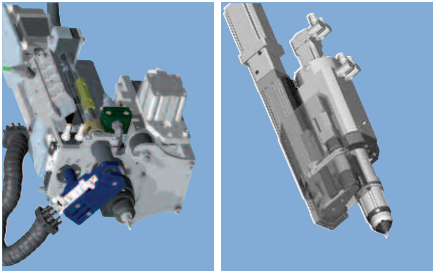
		Semi-automatic tools		Automatic tools		
						
		RIVKLE® EPK C	RIVKLE® EPK HP	RIVKLE® HSA 2.0	RIVKLE® ESA 2.0	
Setting technology	Stroke					
	Force	●	●	●	●	
Drive		Pneumatic / Electric	Pneumatic / Electric	Pneumatic / Hydraulic	Electric	
Accessibility		One side only	One side only	One side only	One side only	
Setting force (kN)	min.	6	20	5	5	
	max.	21	55	32	22	
Ø RIVKLE®	Steel	min.	M4	M8	M4	M4
		max.	M10	M16 / M12 HRT	M10	M8
	Stainless Steel	min.	M4	M8	M4	M4
		max.	M10	M12	M8	M8
	Aluminium	min.	M6	–	M6	M6
		max.	M12	M12 HRT	M10	M8
Control process	Stroke & Force 100%	●	●	●	●	
Use / integration	Manual (operator)	●	●			
	With robot			●	●	
	Special machine			●	●	
RIVKLE® feed system	Manual	●	●			
	"Pick & place"			●	●	
	Automatic			●	●	
RIVKLE® annual volume		++	+	+++	+++	
Cycle time (s)	Loading / speed	1	1,5	2,8	1,7	
	Setting	1	1,5	1	0,9	
	Spin off	1	1,5	1	0,8	
Max production rate (RIVKLE®/min)		20	15	10	13	
Page		6	6	9	10	

RIVKLE® – Full control process power hand tool

RIVKLE® EPK Compact – RIVKLE® EPK HP

Advantages:

- 100% setting (installation) process control
- Pressure setting method
- High production rate
- Multilingual touchscreen
- Adjustable alarm and security devices
- Fault management (device / process)



Theory

The RIVKLE® EPK setting tool offers a manual setting cycle with 100% quality control. This modular range answers to all integration needs (communication and production cycle management). Auto-control of setting force and setting stroke during setting process.

Characteristics



View from back side

- 1 The control unit has an integrated touchscreen that enables adjustment of setting parameters, counter, alarms and manage all the sensors and multiple setting.

Options as stack light, wheels, ... are available

Technical characteristics / Data

	RIVKLE® EPK C	RIVKLE® EPK HP
Code number	282 52 000 003	
Electrical supply	230V - 50Hz	
Pneumatic supply	6 bar	
Setting force	6 to 21 kN	20 to 55 kN
Setting stroke	7 mm	9 mm
Noise level	< 70dB (A)	
Setting head weight "gun type"	2,3 Kg	
Setting head weight "vertical type"	2,5 Kg	7,5 Kg
Cycle time	3 to 4,5 s (*)	4 to 5,5 s (*)
Air consumption	300 l/min	
Power consumption	460 VA	
Production rate	13 to 20 RIVKLE®/min	11 to 15 RIVKLE®/min

(*) production rate depends on the operator and the ergonomics of the work station.

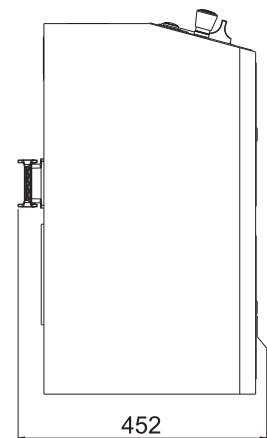
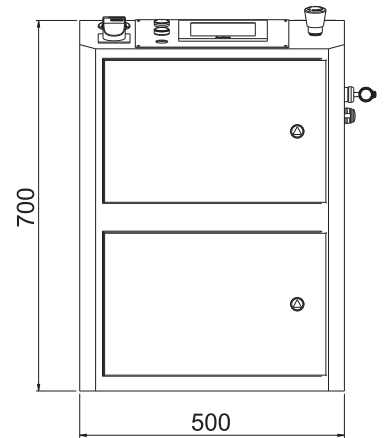

RIVKLE® EPK C Material	Ø RIVKLE®							
	M3	M4	M5	M6	M8	M10	M12	M14
Steel		■	■	■	■	■	■	■
Stainless steel		■	■	■	■	■		
Aluminium				■	■	■	■	

RIVKLE® EPK HP Material	Ø RIVKLE®							
	M4	M5	M6	M8	M10	M12	M14	M16
Steel				■	■	■	■	■
Stainless steel		■	■	■	■	■		
Aluminium						HRT		

RIVKLE® EPK Compact / EPK HP Special accessories



RIVKLE® EPK C
REVOLVER



RIVKLE® EPK C
VERTICAL



RIVKLE® EPK C
HORIZONTAL



RIVKLE® EPK C
REVOLVER TOP



RIVKLE® EPK C
VERTICAL 1 HAND



RIVKLE® EPK HP



RIVKLE® EPK HP
HORIZONTAL



RIVKLE® EPK
REVOLVER



RIVKLE® EPK
VERTICAL

RIVKLE® – Automatic setting systems

Advantages:

- Pick & Place: management of the RIVKLE® orientation and distribution
- Automatic reloading: RIVKLE® distribution by a blow-feeding process
- Up to 4 setting heads fed with only 1 bowl feeder
- Recycling of disorientated RIVKLE® avoiding the line breakdown

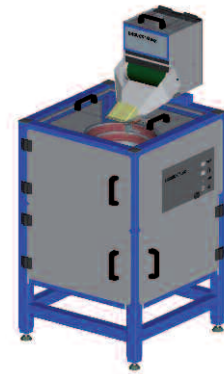

The automatic setting tool range is optimised for integration into production lines. The setting heads can be used with a RIVKLE® automatic feeding system (vibratory bowl feeder).

The choice between RIVKLE® HSA 2.0 and RIVKLE® ESA 2.0 range depends on the type of energy (pneumatic/hydraulic or electric).

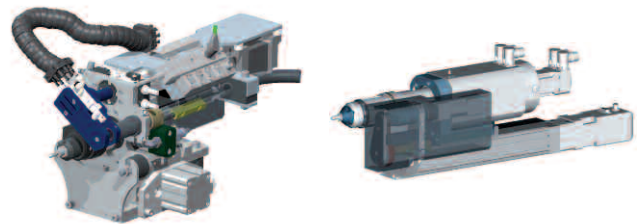

Pick & place configuration

The setting head moves to the bowl feeder to pick up the RIVKLE® and moves to the workpiece to set the RIVKLE®.

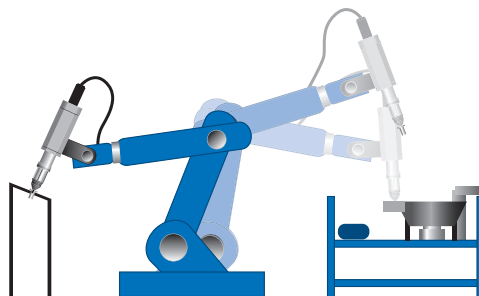

Blow-feed configuration

The RIVKLE® are automatically blow-fed from the bowl feeder to the setting head.

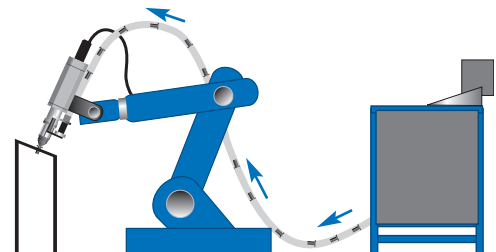

Integration

The automatic setting heads can be installed in several configurations:

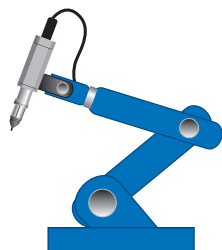

On a robot

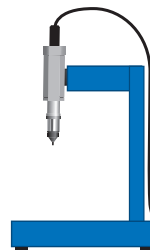

Stationary

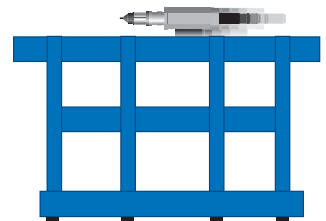

On a transfer system

RIVKLE® HSA 2.0 – Automatic setting tool

Advantages:

- Robust and reliable setting unit
- Complete process control
- Integrated automatic loading system
- Recycling incorrectly pre-loaded RIVKLE® without interruption
- Collision control
- Communication capabilities (Ethernet, TOR, Fieldbus)

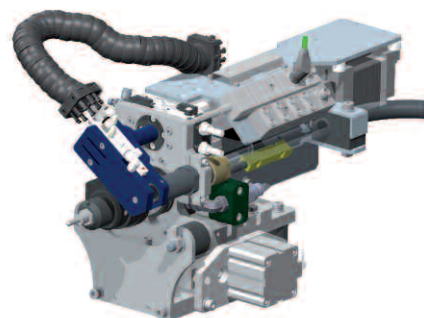

The RIVKLE® HSA 2.0 equipment has been designed for high volume production with optimised reliability and ease of installation and maintenance.

Pneumatic/hydraulic energy

The RIVKLE® HSA 2.0 heads use oil for the setting process and air for all head movements.

- Ease of maintenance
- Flexibility

Compensation

A compensator (robot or fixed) allows compensation of RIVKLE® alignment to the part. The robot compensator includes a clamping device in order to lock the head during rapid movements of the robot.

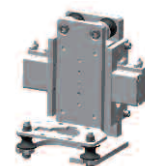

Robot compliance

Control unit

The RIVKLE® HSA 2.0 control unit manages the whole setting and feeding cycles and controls the bowl feeder. Control unit enables communication with the customer's network (Ethernet,...) and can control several setting heads and bowl feeders at the same time (up to 8 heads and 4 bowl feeders with a single control unit).

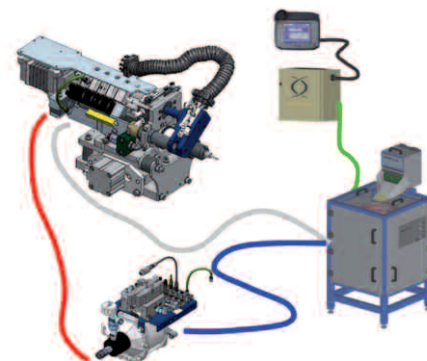

Technical characteristics

Electrical supply	110V / 230V
Setting force	5 to 32 kN RIVKLE® M4 to M10
Setting stroke	28 mm max stroke (setting + unscrewing)
Embedded weight	23 kg max
Loading time	2,8 s (can be done during robot movement)
Setting and spin off time	2,0 s movement of the robot and movement of the workpiece not included

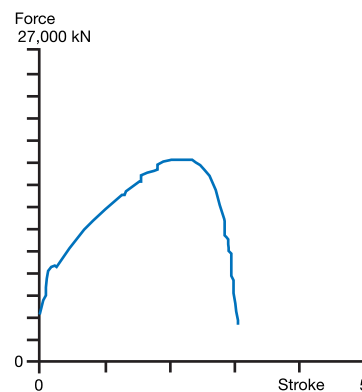

Peak force = 17,81 kN - Stroke = 2,21 mm

RIVKLE® ESA 2.0 – Automatic setting tool

Advantages:

- 100% electrical tool
- Robust and reliable setting unit
- Complete process control
- Integrated automatic loading system
- Recycling incorrectly pre-loaded RIVKLE® without interruption
- Collision control
- Communication capabilities (Ethernet, Fieldbus)

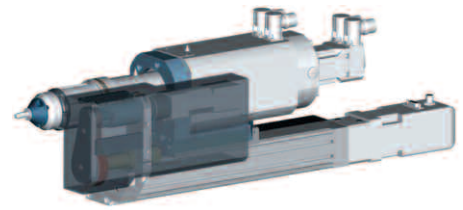

The new RIVKLE® ESA 2.0 equipment range offers a fully electric and automatic setting solution. Installed on a transfer module, the RIVKLE® ESA 2.0 integrates a linear slide module to control the placement of the RIVKLE® into the workpiece.

Electrical energy

Only electrical energy is necessary to control the RIVKLE® ESA 2.0 (functions and movements).

- Very precise movement control and measurement.
- Very low noise level.
- Repeatable and very low cycle times compared to pneumatic/hydraulic equipment.

Compensation

A compensation system that allows radial (+/- 1.5mm) and angular (+/- 3°) adjustments is directly integrated into the nose.

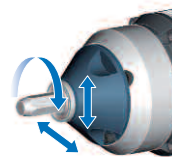

Transfer

The equipment integrates a 200 mm or 300 mm linear movement system to guarantee correct RIVKLE® placement into the workpiece. This movement is also used in the reloading process.

Control unit

The control unit includes 4 servo-regulators to control and measure all the RIVKLE® ESA 2.0 setting unit movements. A touchscreen permits adjustment of various parameters. To assist in complete integration the length of the electric cables between the control unit and the head is unlimited.

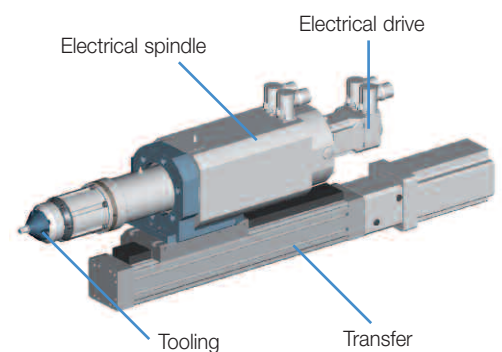

Pick and Place configuration

Technical characteristics

Electrical supply	400 Vca + N
Setting force	From 5 to 22 kN
Setting stroke	10 mm
Weight	28,5 kg (BF configuration)
Loading time	1,7 s (BF configuration)
Setting and spin off time	1,7 s

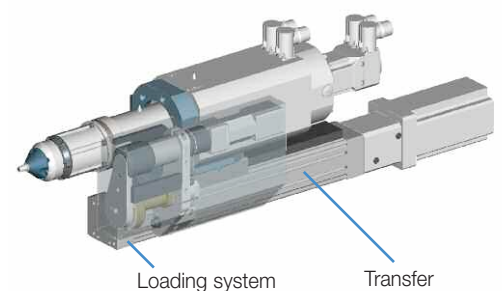

Blow feed configuration

RIVKLE® – Applications

Böllhoff is working in all fields of industrial activity and can propose an optimised solution for each type of application.



Automotive



Construction machinery



Agricultural machinery



Others industries



Railways

Böllhoff service and expertise

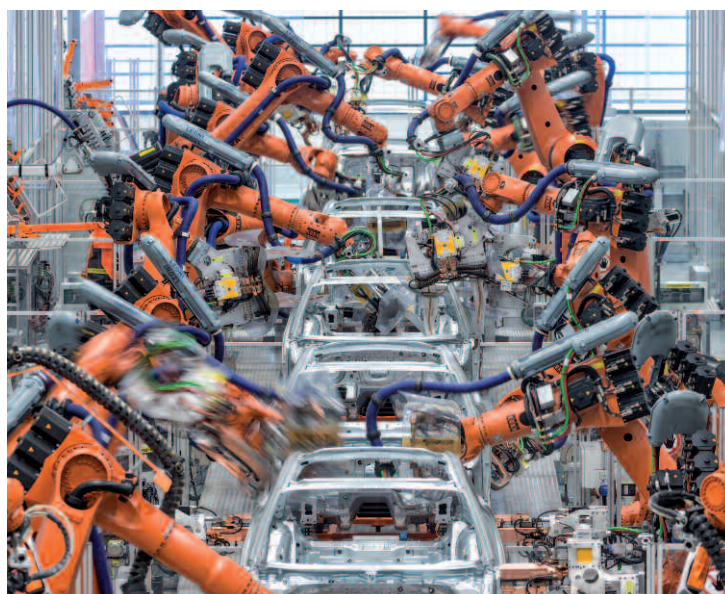

Böllhoff International with companies in:

Argentina
Austria
Brazil
Canada
China
Czech Republic
France
Germany
Hungary
India
Italy
Japan
Mexico
Poland
Romania
Russia
Slovakia
South Korea
Spain
Switzerland
Thailand
Turkey
United Kingdom
USA

Apart from these 24 countries, Böllhoff supports its international customers in other important industrial markets in close partnership with agents and dealers.

Böllhoff Group
Please find your local contact on www.boellhoff.com
or contact us under fasteningtechnology@boellhoff.com

